



INSTALLATION INSTRUCTIONS

Accessory
EXHAUST PIPE FINISHER
P/N 08F53-T0A-100

Application
2016 CR-V

Publications No.
VERSION 1
Issue Date
SEP 2015

Put this information in the glove box with the vehicle owner's manual.

PARTS LIST

Exhaust pipe finisher

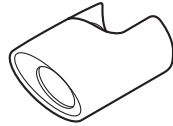

Washer-bolt



TOOLS AND SUPPLIES REQUIRED

Ratchet
10 mm Socket
Torque wrench

Illustration of the Exhaust Pipe Finisher on the Vehicle

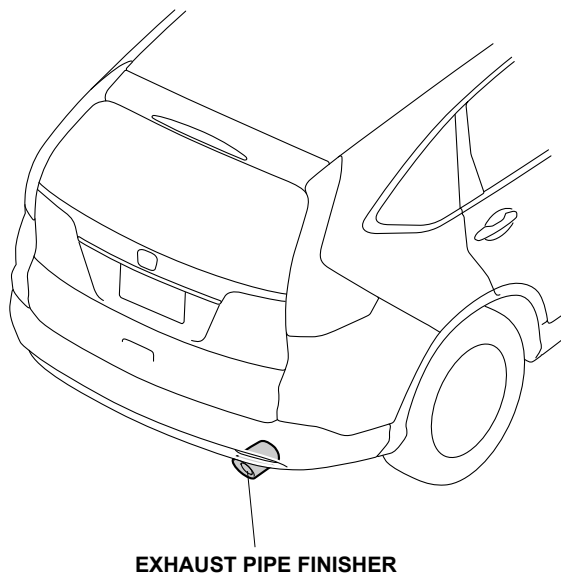

INSTALLATION

NOTE:

- Install the accessory with care not to damage the vehicle body and the parts of the vehicle.
- The exhaust pipe finisher is designed exclusively for the CR-V, it is not applicable to the other models.
- Allow the exhaust pipe to cool down before installing the exhaust pipe finisher.

1. Partially thread the washer-bolt into the exhaust pipe finisher. Slide the exhaust pipe finisher onto the exhaust pipe.

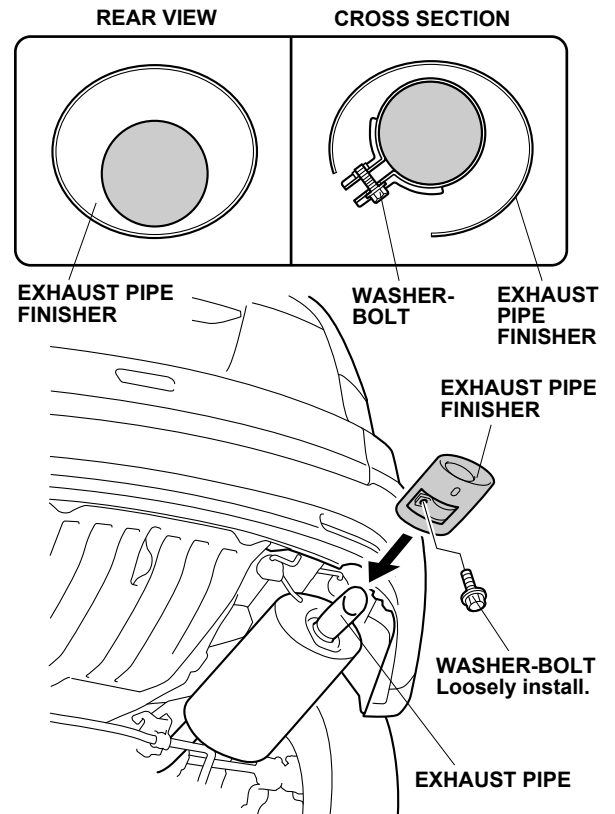

2. Continue to slide the exhaust pipe finisher in until it contacts the end of the exhaust pipe. While holding the exhaust pipe finisher firmly against the exhaust pipe, torque the washer bolt to 10 N·m (7 lbf·ft).

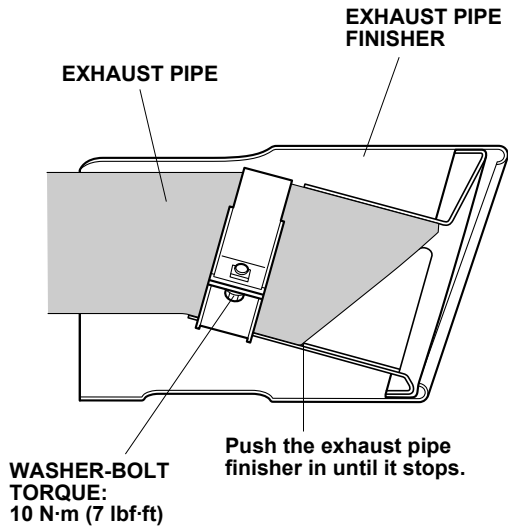

3. Start the engine, and rev it up a few times. Listen for vibration from the exhaust pipe finisher, and adjust if necessary.

CLEANING THE EXHAUST PIPE FINISHER

Use a sponge or cloth and a solution of mild liquid dishwashing soap and water to clean the exhaust pipe finisher. Wax the exhaust pipe finisher using Honda Metal Polish (08C20-A021S). Never use a wax that contains abrasive material as it may scratch the surface.