



INSTALLATION INSTRUCTIONS

Accessory
REAR SPLASH GUARDS
P/N 08P09-SJC-100A

Application
2010 RIDGELINE

Publications No.
All 42148
Issue Date
AUG 2009

PARTS LIST

Left rear splash guard

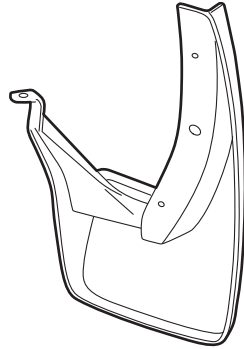

Right rear splash guard

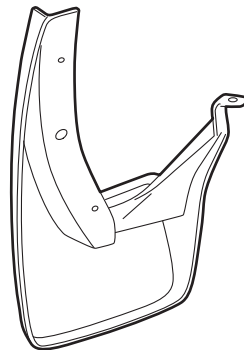

2 Clips

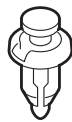

4 Self-tapping screws



TOOLS AND SUPPLIES REQUIRED

Stubby Phillips screwdriver

Flat-tip screwdriver

INSTALLATION

Customer Information: The information in this installation instruction is intended for use only by skilled technicians who have the proper tools, equipment, and training to correctly and safely add equipment to your vehicle. These procedures should not be attempted by “do-it-yourselfers.”

NOTE:

- Do not damage the body paint finish.
 - Wash and wax the areas to be covered. Use a high quality paste wax.
1. Remove two vehicle self-tapping screws from the rear bumper on the left side.

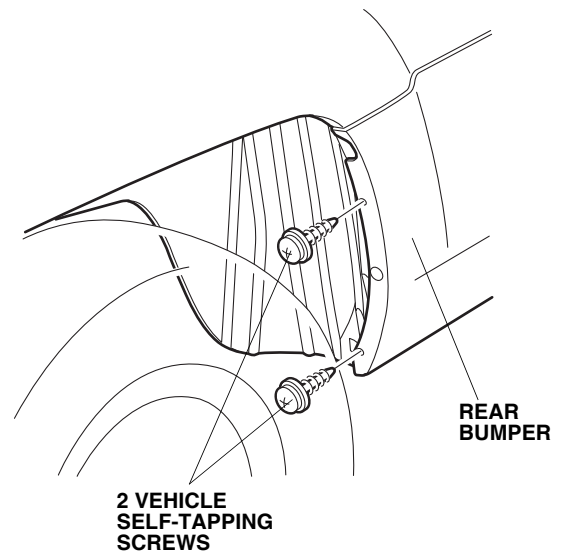

2. Remove one vehicle clip from the left rear inner fender.

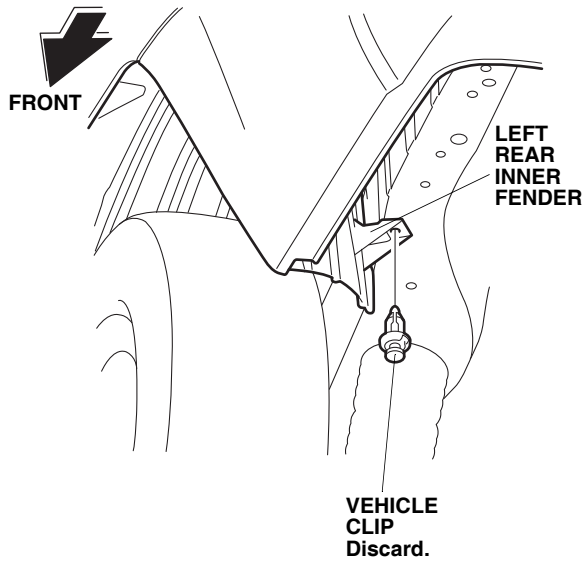

3. While holding the left rear splash guard against the vehicle, secure the splash guard with one clip.

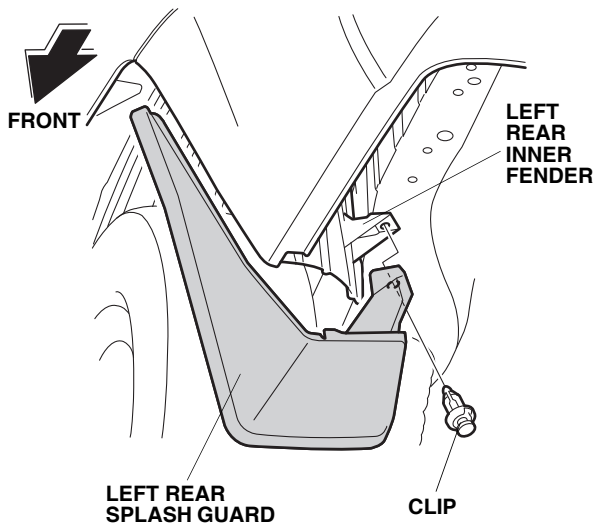

4. Install the left rear splash guard with two self-tapping screws in the order shown. Make sure that there is no space between the rear bumper and the splash guard before tightening the screws.

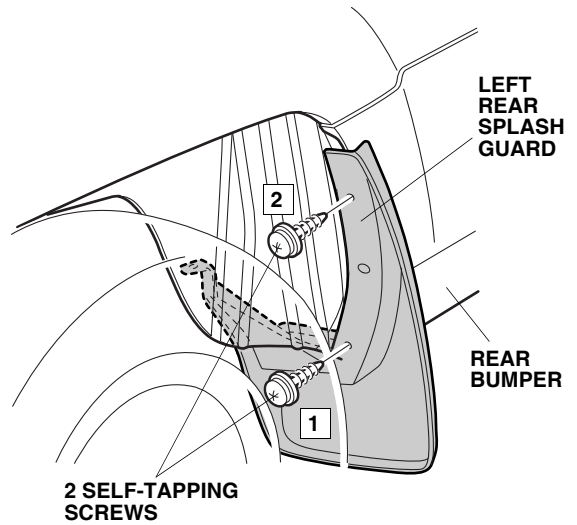

5. Repeat steps 1 through 4 on the right side of the vehicle.